

eduard
MASK

P-38 Lightning 1/48

The die-cut mask for accurate canopy frame painting of the
Hasegawa 1/48 KIT

EX 072

LIQUID MASK

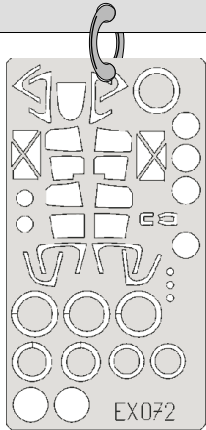

2x
Q14

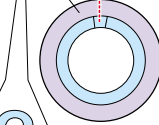
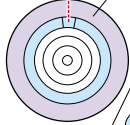

2x
Q4

2x
Q15

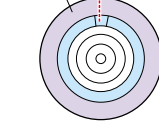
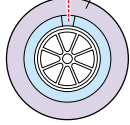

2x
Q5

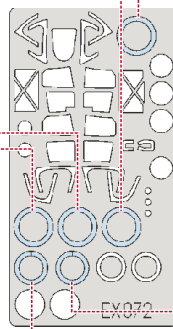

LIQUID MASK

M23

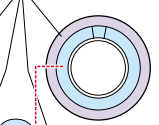
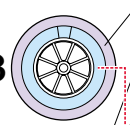

M22

M23

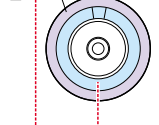
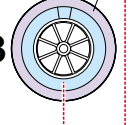

M22

2x
Q15

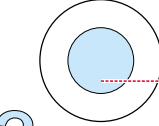
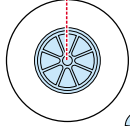

2x
Q4

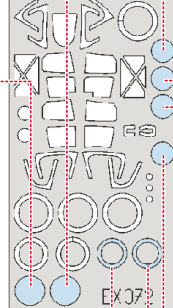

M23

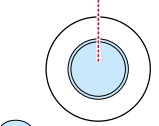
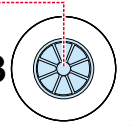

M22

2x
Q14

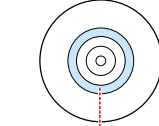
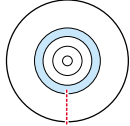

2x
Q5

M23

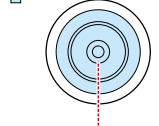
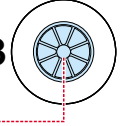

M22



1.)

U12

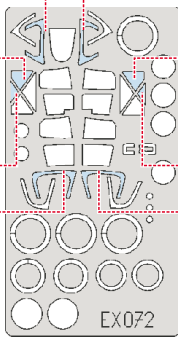
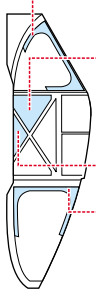

U12

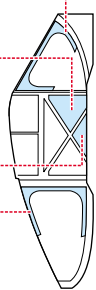

U8

U7

U13

U13

2.)

U12

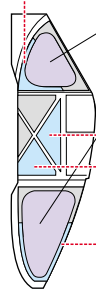

LIQUID MASK

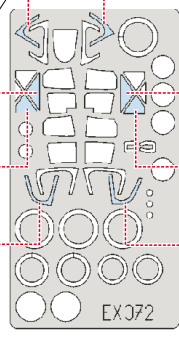

U12

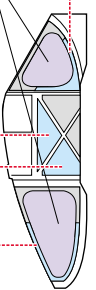

U8

U7

U13

U13

3.)

U12

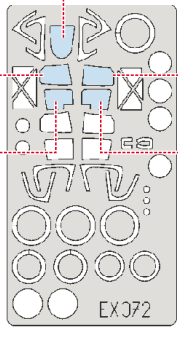
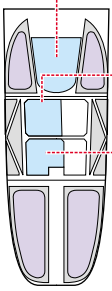

U12

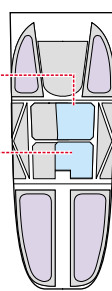

U5

U5

4.)

U4

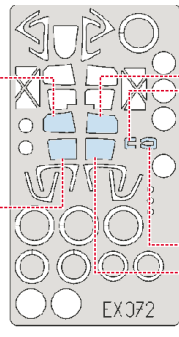
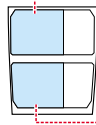

U1

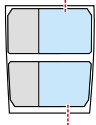

U4

5.)

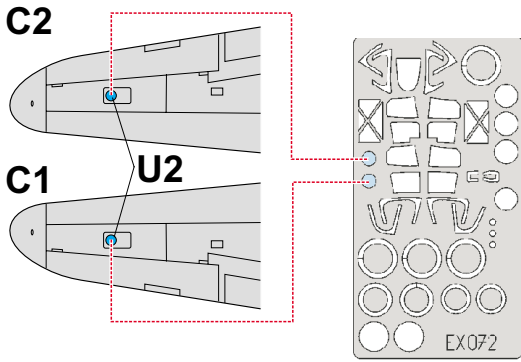

6.)

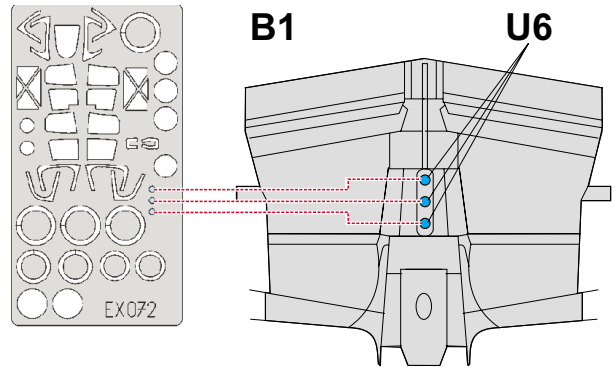

7.)

INTERIOR COLOR

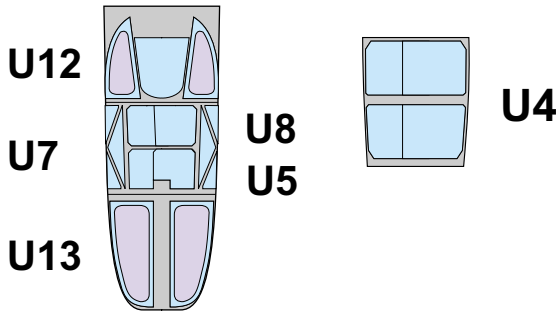

8.)

CAMOUFLAGE COLOR

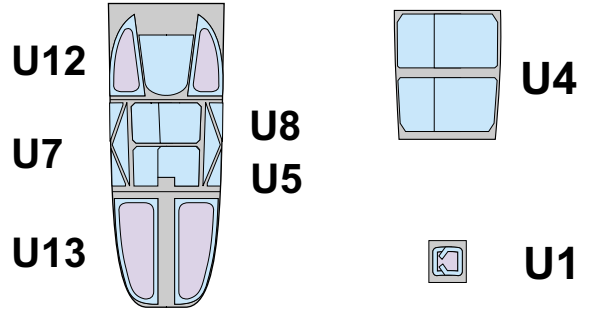

9.)

TIRE COLOR

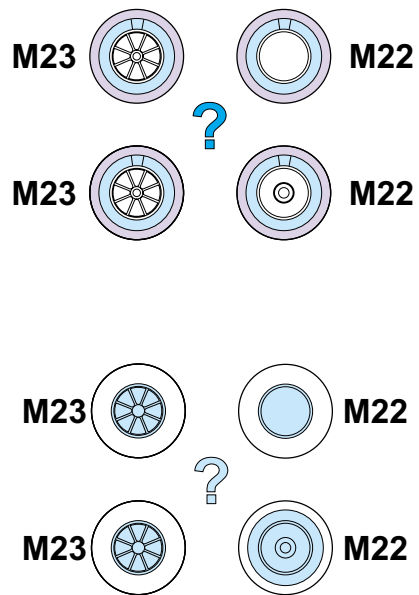
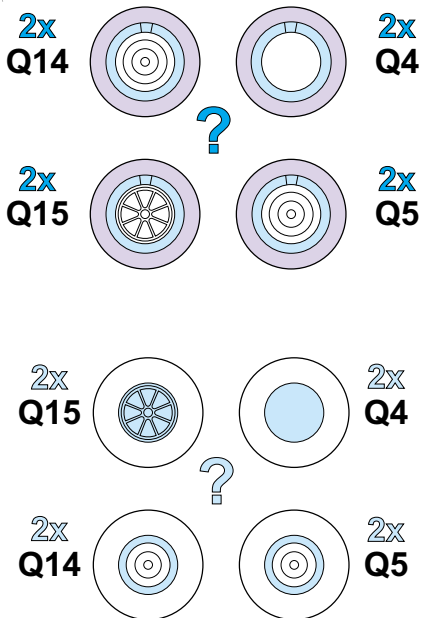

REFERENCES: Squadron/Signal Publ.: In action # 1109 - P-38 Lightning
 Replic #26
 Aero Detail P-38