

eduard
MASK

Do 217E 1/48

The die-cut mask for accurate canopy frame painting of the
Revell / Monogram scale 1/48 KIT

EX 103

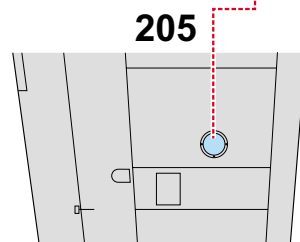
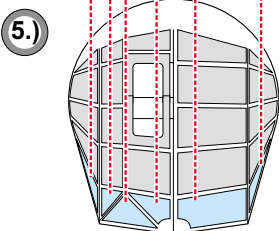
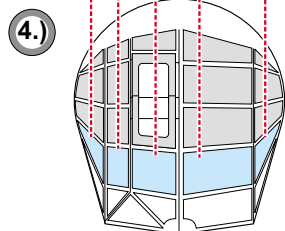
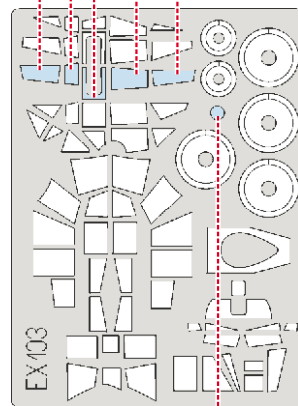
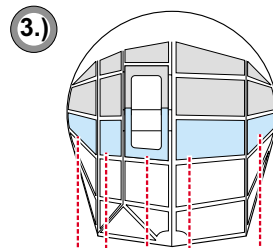
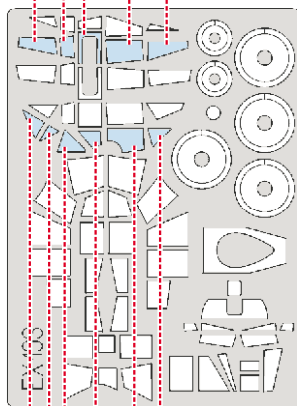
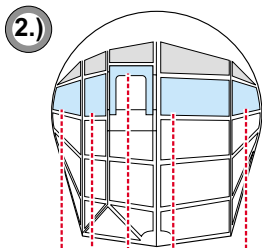
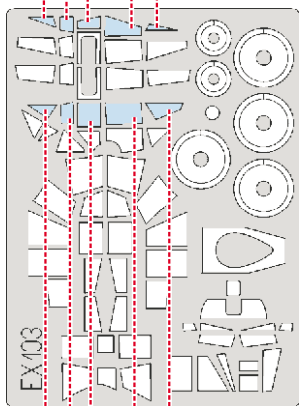
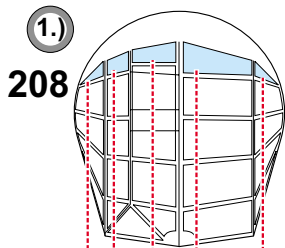
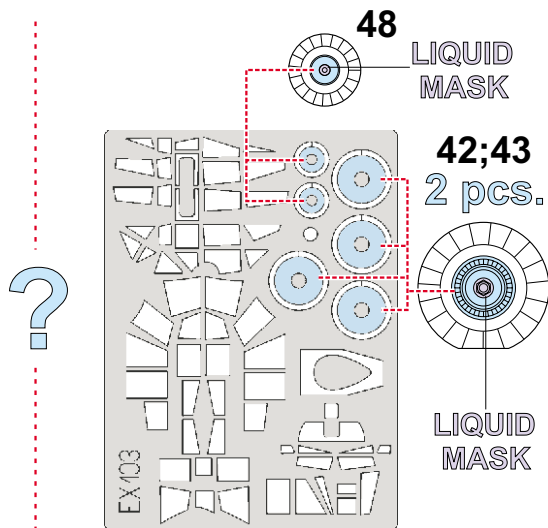
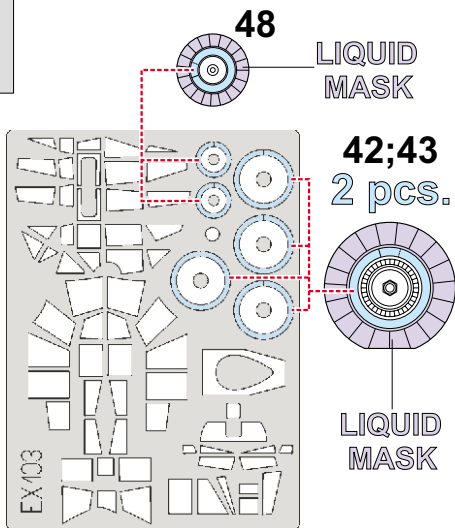
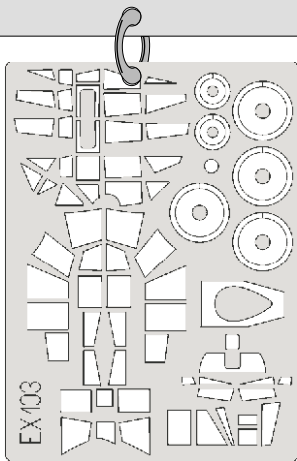

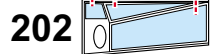
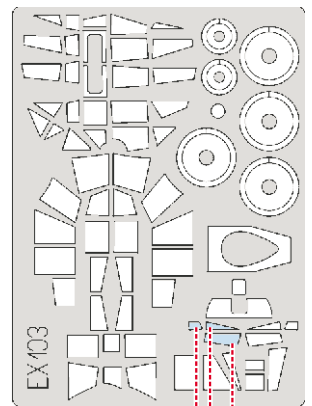
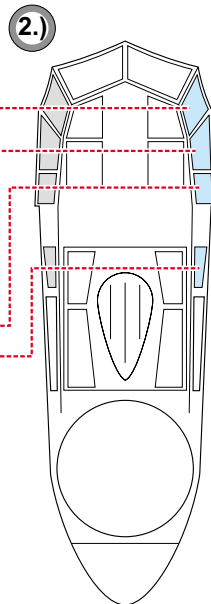
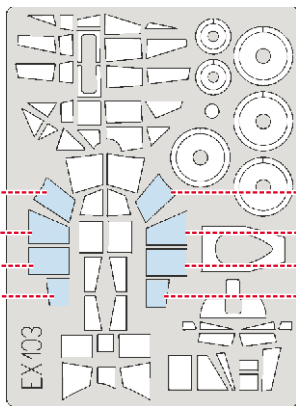
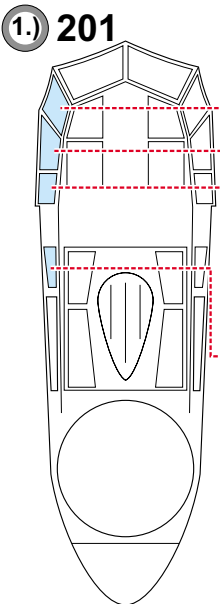
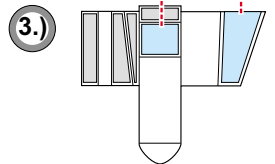
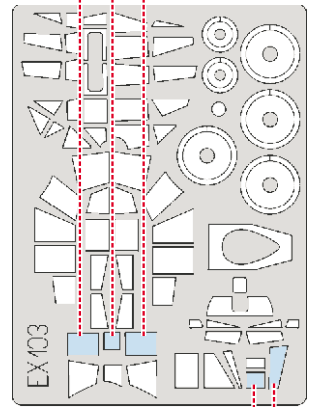
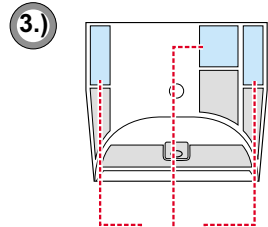
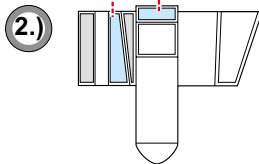
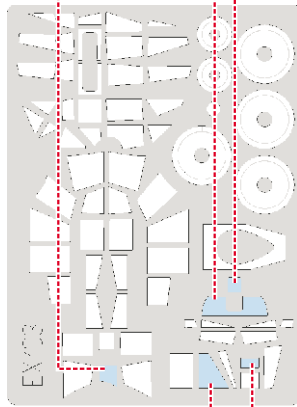
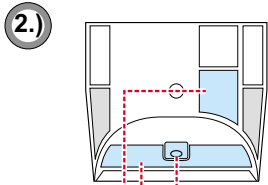
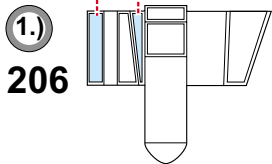
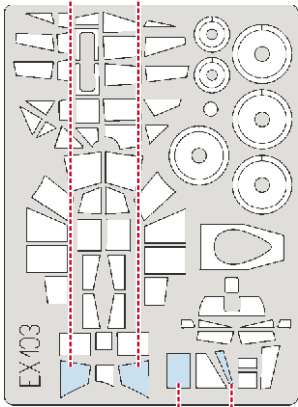
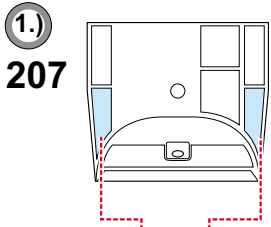

3.)

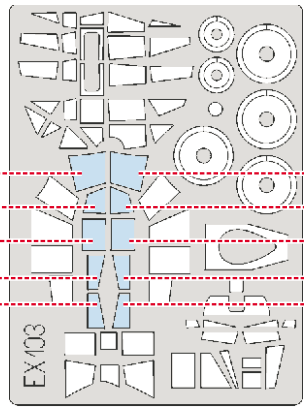
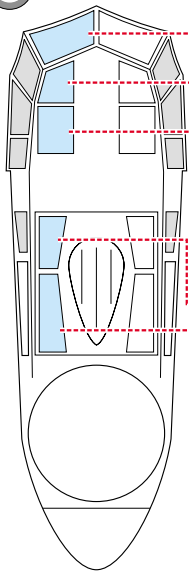

4.)

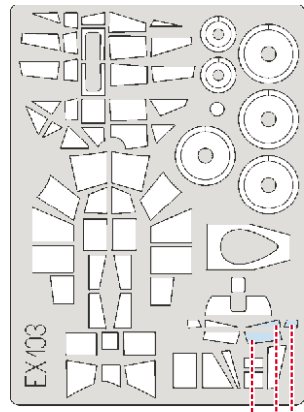
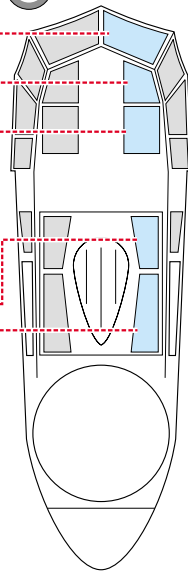

203

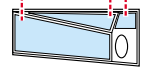

INTERIOR COLOR

CAMOUFLAGE COLOR

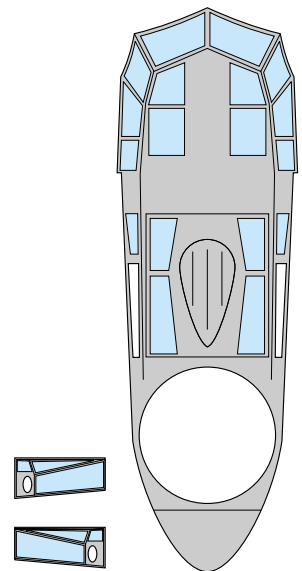
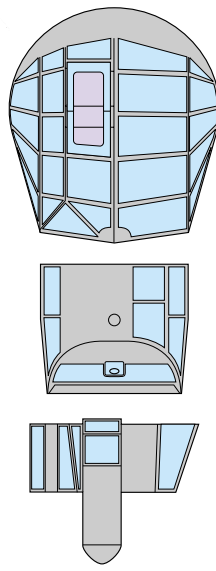
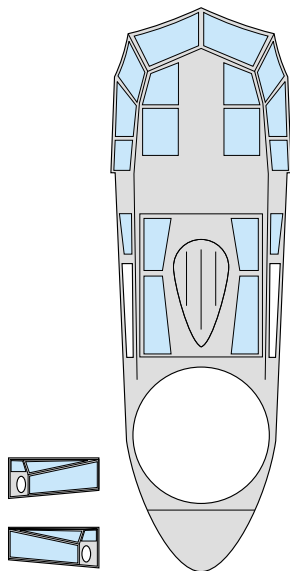
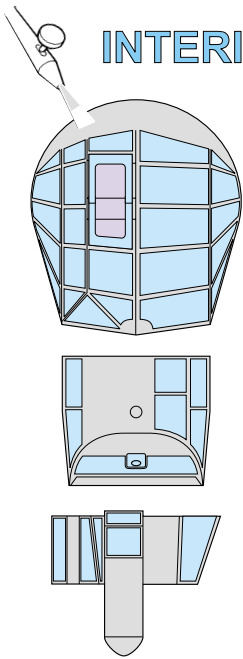

■ - LIQUID MASK

1.) 201

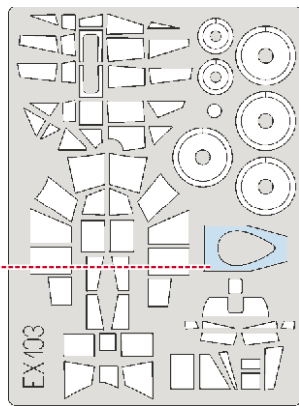
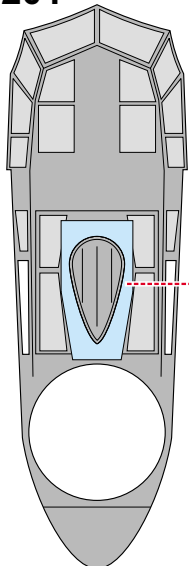

2.)

Refer to documentation for choice of style for radome colour, either clear or painted.

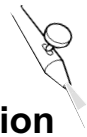

LIQUID MASK

