

eduard
MASK

F-101 Voodoo 1/48

The die-cut mask for accurate canopy frame painting of the
Revell/Monogram scale 1/48 KIT

EX 108

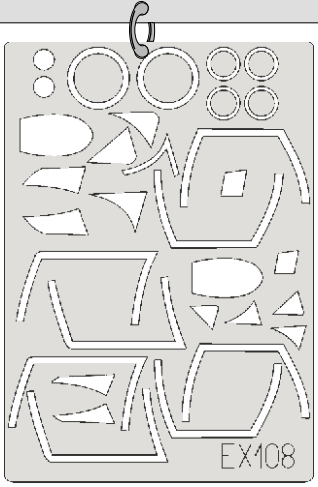

83
2pcs

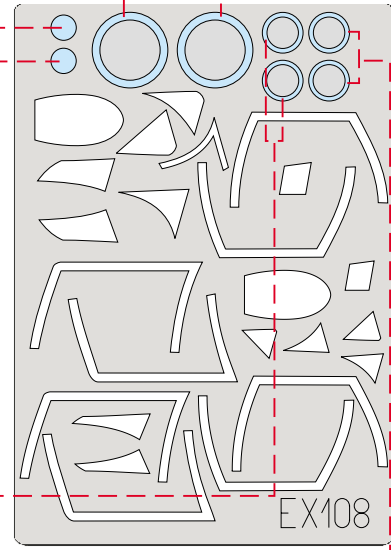

41
2pcs

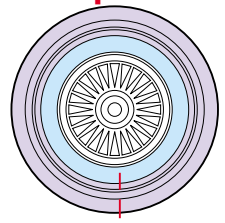

24
2pcs

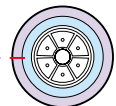

24
2pcs

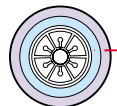

REFERENCES:
AEROFAX MINIGRAPH #5

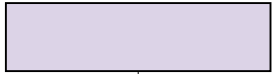

LIQUID MASK

1.)

81

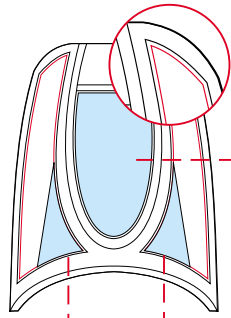

2.)

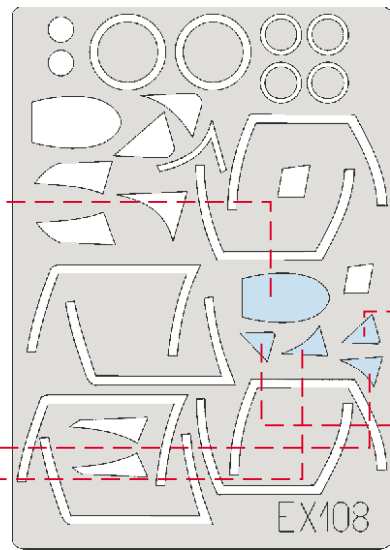
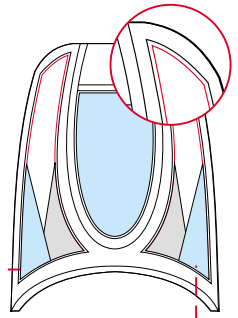

3.) INTERIOR COLOR

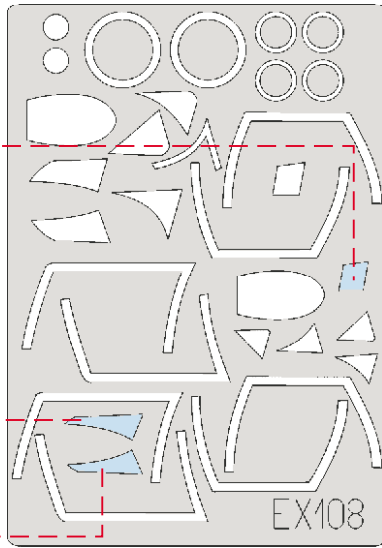
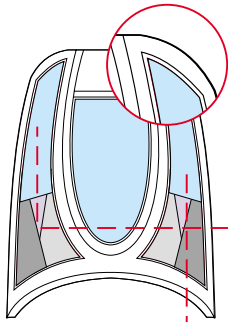
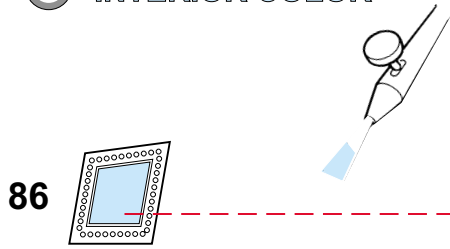

4.) RUBBER COLOR

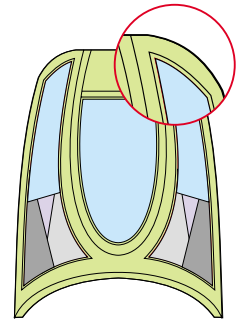
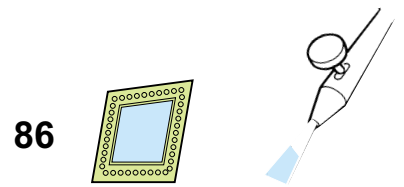

5.)

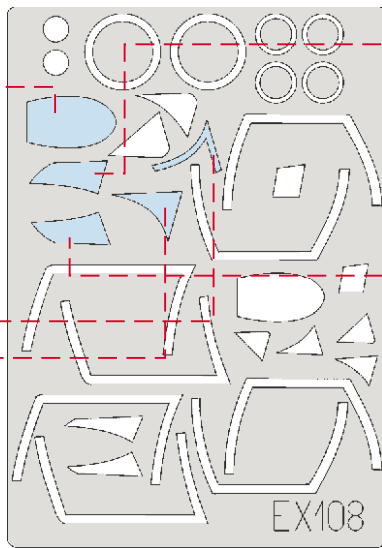
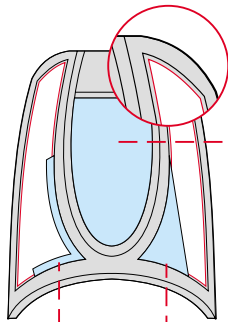

6.)

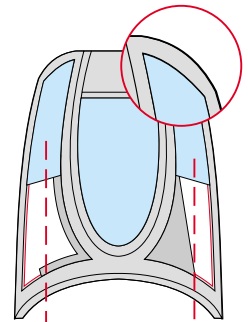

CAMOUFLAGE COLOR

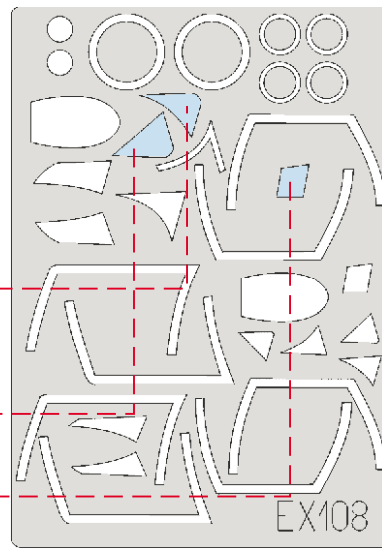
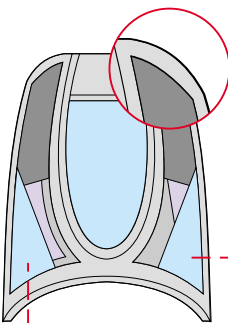
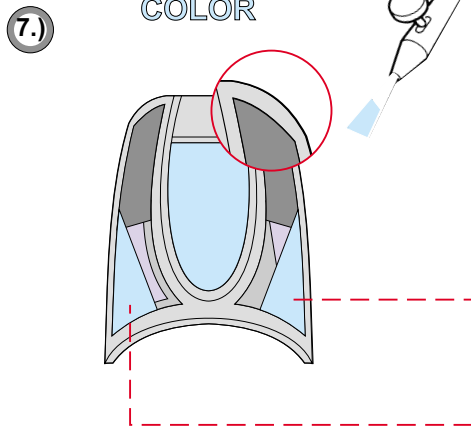

8.)

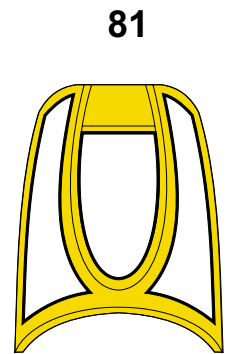

86

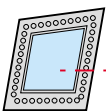

81

86

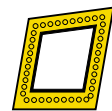

1.)

82

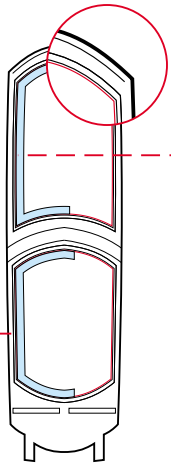

2.)

INTERIOR COLOR

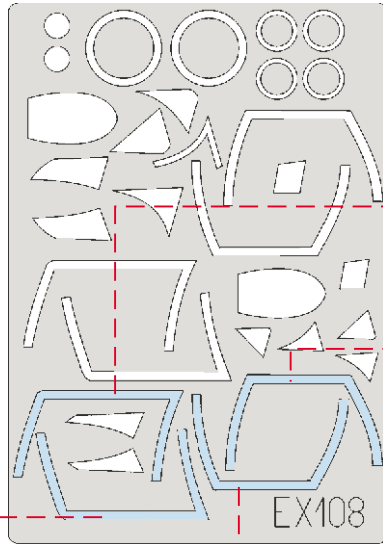
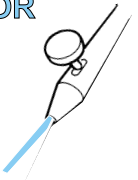
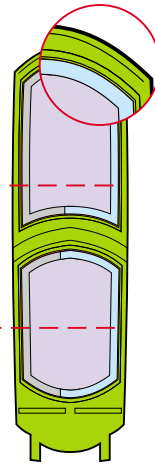

3.)

RUBBER COLOR

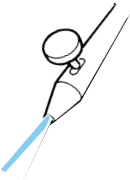
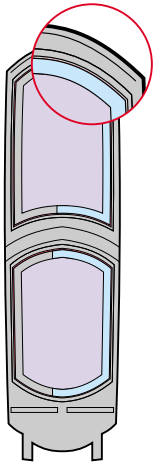

4.)

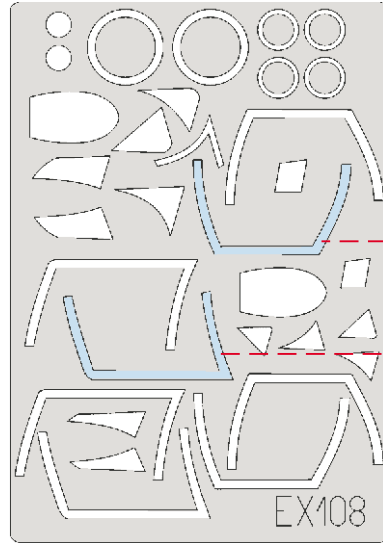
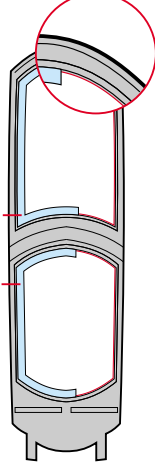

5.)

CAMOUFLAGE COLOR

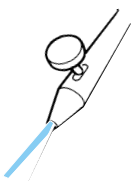
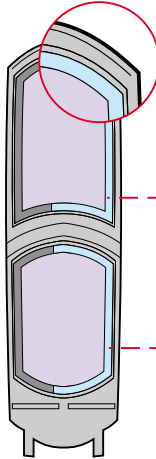

6.)

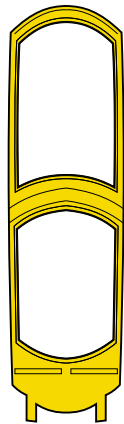

82

