

# 648 687 Ar 234B wheels

for Hasegawa / Hobby 2000 kit -  
pro stavebnici Hasegawa / Hobby 2000

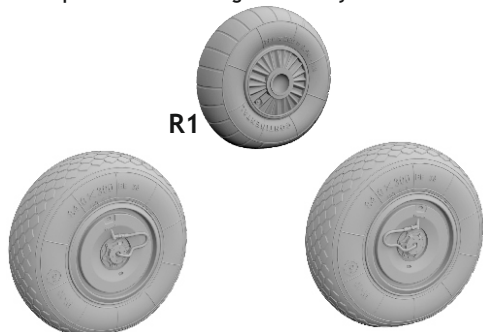

1/48 scale



R1

R2

R3

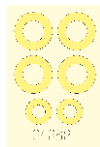

## COLOURS

GSI Creos (GUNZE)		Mr.METAL COLOR
AQUEOUS	Mr.COLOR	
<span style="border: 1px solid black; padding: 1px;">H 2</span>	<span style="border: 1px solid black; padding: 1px;">C 2</span>	BLACK
<span style="border: 1px solid black; padding: 1px;">H 77</span>	<span style="border: 1px solid black; padding: 1px;">C 137</span>	TIRE BLACK

**eduard**

435 21 Obrnice 170  
Czech Republic

www.eduard.com  
9,95



# 648 687

# Ar 234B wheels











for Hasegawa / Hobby 2000 kit -  
pro stavebnici Hasegawa / Hobby 2000

1/48



**eduard**



-  REMOVE  
ODSTRANIT
-  BEND  
OHNOUT
-  GRIND  
OBROUSIT
-  ? OPTION  
VOLBA
-  DRILL HOLE  
VRTAT OTVOR
-   REPLACE  
NAHRADIT
-  SYMMETRICAL ASSEMBLY  
SYMETRICKÁ MONTÁŽ
-  SCRIBE THE PANEL AND HOLES  
RYTI
-  REVERSE SIDE  
OTOČIT

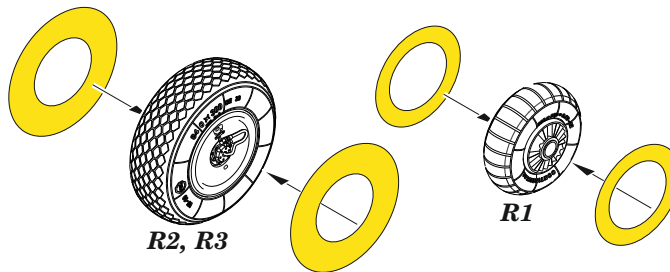
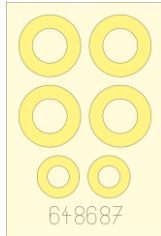

### CORRECT POSITION OF WHEELS

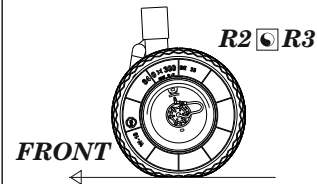

### CORRECT POSITION

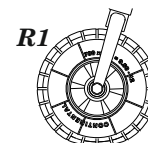

1

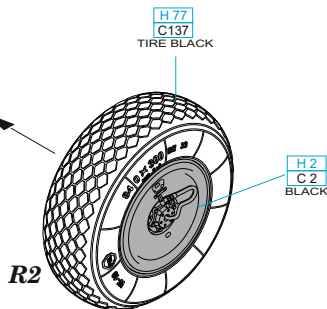
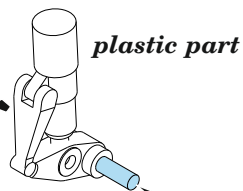
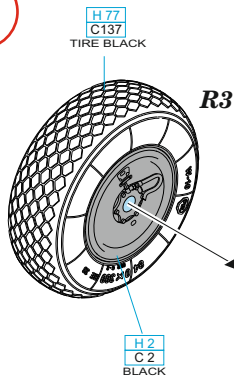

2

